

# HITCH INSTALLATION INSTRUCTIONS

MAKE: YEARS: MODEL/TRIM:  
 TESLA 2017-2023 3

RACK RECEIVER KIT BOX#: **SHR09001**

COMPATIBLE WITH TOW KIT: **SHT25048**

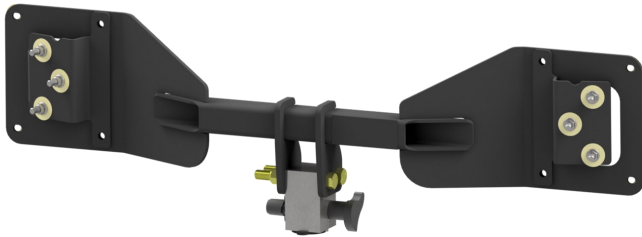

**2" RACK RECEIVER MAXIMUM PAYLOAD: 350 LBS**  
**MAXIMUM TOW RATING: 3500 LBS**  
**MAXIMUM TONGUE WEIGHT: 350 LBS**

## UNDER VEHICLE TRIMMING:

HEAT SHIELD: **NO**  
 FASCIA: **NO**  
 GRAVEL GUARD TRIMMING:  
**EARLY MODELS ONLY**

 **READ ALL INSTRUCTION WARNINGS AND LABELS**

 **NO WELDING, METAL DRILLING, OR VISIBLE TRIMMING REQUIRED**

### PARTS SUPPLIED WITH RACK RECEIVER KIT:

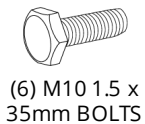
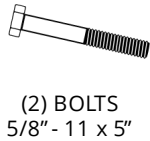
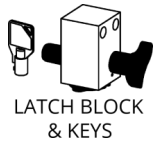

### ADDITIONAL PARTS FOR TOW KIT:



### TOOLS REQUIRED:



### ADDITIONAL TOOLS FOR TOW KIT:



# <THESE INSTRUCTIONS MUST BE GIVEN TO THE END USER>

**NOTICE:** Installation of Stealth products may or may not require the addition of a wiring harness to the vehicle.









- The Rack Receiver only product does not require adding a wiring harness.
- The Rack Receiver plus Tow Kit requires the addition of a "Passive" wiring harness to the vehicle. The passive harness "reads" the output of the vehicle's lights and translates the signals to the trailer without being connected to the vehicle computer.

**INSTALLATION NOTE:** In most instances, these instructions will only outline disassembly of vehicle components. Re-installation of components will require the installer to retain vehicle hardware and work through disassembly instructions in reverse order. When installation is complete, double check that all vehicle components have been replaced and are secured.

## IMPORTANT SAFETY NOTICE FOR STEALTH HITCH INSTALLERS AND CUSTOMERS.

Read all installation and operating instructions along with all labels before installing or using this product. Do not perform any installation or towing procedures without fully understanding the correct tools and actions for all steps. Call for support if needed.

### **WARNING** Failure to comply with the safety information in these instructions could result in serious injury or death.

-  Do not modify this product in any manner. Doing so could alter its integrity and lead to a loss of attachment between the trailer and the tow vehicle.
-  Adding Stealth hitch components to the chassis of any vehicle can be hazardous. There is potential for unexpected combustion of fuel, electric shock, burns, shifting or falling of unstable vehicle, damage to vehicle, injury from tool usage and many other hazards. This installation must be completed by someone who is aware of the hazards involved. This person must be knowledgeable of proper safety procedures for a vehicle modification of this nature, and for usage of the equipment required to perform the installation.
-  Without proper knowledge, towing can be a dangerous activity. Understand all the risks involved with towing before proceeding. For information on towing safety, see "**The Trailer Handbook: A Guide to Understanding Trailer and Towing Safety**" from the National Association of Trailer Manufacturers, [www.NATM.com](http://www.NATM.com) and your trailer and tow vehicle manufacturer's owner's manual.
-  Do not exceed tow or tongue rating of coupler, tow or tongue rating of hitch, or tow or weight ratings of tow vehicle or trailer. See vehicle and trailer manufacturer information for ratings. Exceeding these ratings may cause damage to towing components or loss of attachment between the trailer and vehicle.
-  While installation is being performed, check for signs of damage or excessive corrosion. Do not install hitch components over vehicle parts that are broken or have compromised structural integrity.
-  This product was designed to fit vehicles in their original, "as manufactured" condition. Compatibility with vehicles having replacement parts, or other modifications is not guaranteed. Inspect vehicle for modifications before installation of this product.
-  Some accessories, like the rack receiver, are not rated for towing. Do not use any accessories without proper knowledge of their use.
-  A visual inspection of the hitch should be performed before each use. Regularly check that all connections are secure, including those that secure the hitch to the vehicle. Check for cracks or damage to the hitch. Do not use the hitch if cracks or damage outside of normal wear is found. Using a hitch that has unsecure connections and/or cracks or damage could result in damage to the tow vehicle, trailer, towing components and loss of attachment between the tow vehicle and trailer.
-  Stealth hitches are not compatible with any weight distribution or sway control products. Adding additional products to the trailer or chassis which modifies the function of the Stealth hitch may cause hitch failure.

**NOTICE:** Installation of hitch requires removal of vehicle parts and interaction with vehicular electronics. Before installation, check the condition of body panels and note any locations where panels are not flush. Check the electronic functions of the vehicle, such as: headlights, taillights, turn signals, cameras, backup sensors, Parking Distance Controller (PDC), foot activated cargo access, etc. It is the responsibility of the installer to restore the fit and function of the vehicle.

## GAIN ACCESS TO MOUNTING AREA



1. Inside the trunk, open up both rear side panels to gain access to taillights. If present, use a 90 degree pick to remove (1) plastic rivet on driver side of the vehicle.
2. Remove (2) plastic trunk stops on top of the taillights by turning counterclockwise.

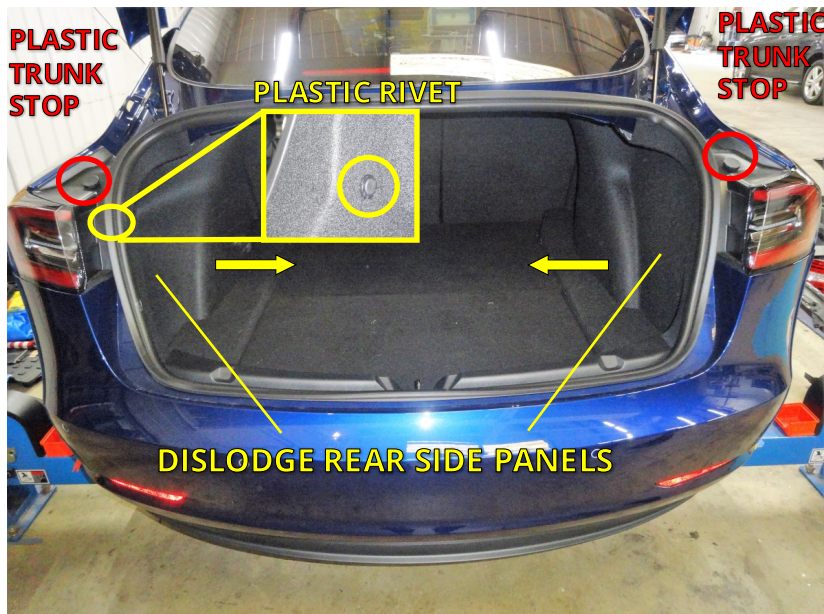

- TIP: Use a plastic clamp to secure the top of the plastic panel when opening the side panel liner. This prevents the plastic panel from dislodging and deforming.



3. Unplug the wiring harnesses from the taillights. Locate nuts (2) securing the taillights to the vehicle on either side of the trunk and remove.

**NOTE:** In some cases, it may be helpful to dislodge the light from the vehicle for better access to the plugs.

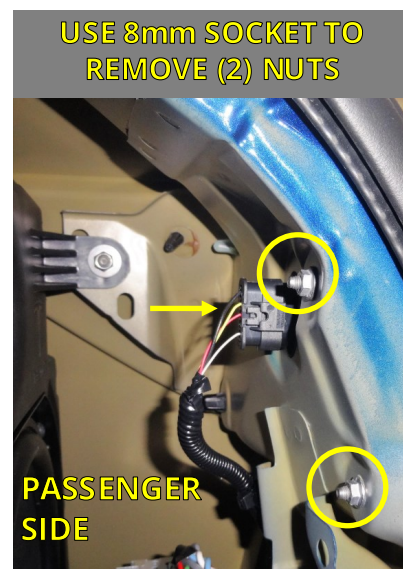
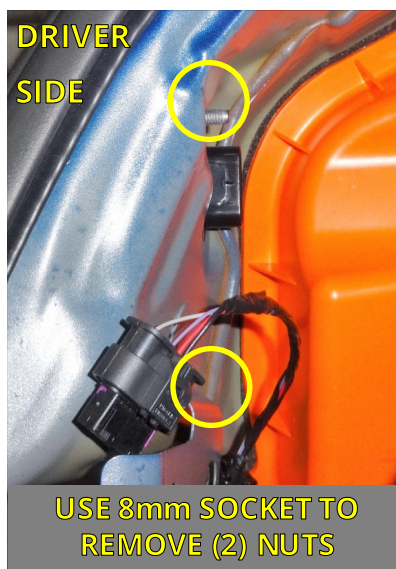



## GAIN ACCESS TO MOUNTING AREA CONTINUED



PLASTIC PRY TOOLS



10mm SOCKET

- Remove taillights by sliding to the rear of the vehicle. A plastic pry tool can be used if necessary.

**NOTICE:** Moving the taillight excessively side to side while prying out light may damage the plastic tabs on backside of light.

- Use a socket to remove screw in the bottom of each light location.



PHILLIPS HEAD SCREWDRIVER



10mm SOCKET

- A mud guard may be present behind the rear tires on some vehicles. If present, use a screwdriver to remove (1) screw rivet behind the tire and a socket to remove (1) screw on the other side of the bracket under the fascia. Unclip and remove the guard from the vehicle. Repeat on the other side of the vehicle.



90 DEGREE PICK



T25 TORX

- Separate the wheel well liner from the rear fascia by removing (3) plastic rivets and (1) Torx screw inside the rear wheel fender.





## GAIN ACCESS TO MOUNTING AREA CONTINUED



90 DEGREE PICK



10mm SOCKET

8. Disconnect the bottom of the fascia and gravel guard from the vehicle body. Use a 90 degree pick to dislodge (2) plastic covers. Next, use a socket to remove the screws from the gravel guard. Most models will have (7) screws. Some models may have (6) screws, and on some models an 8th screw may be present. Pull down the rear gravel guard to gain access to this screw.

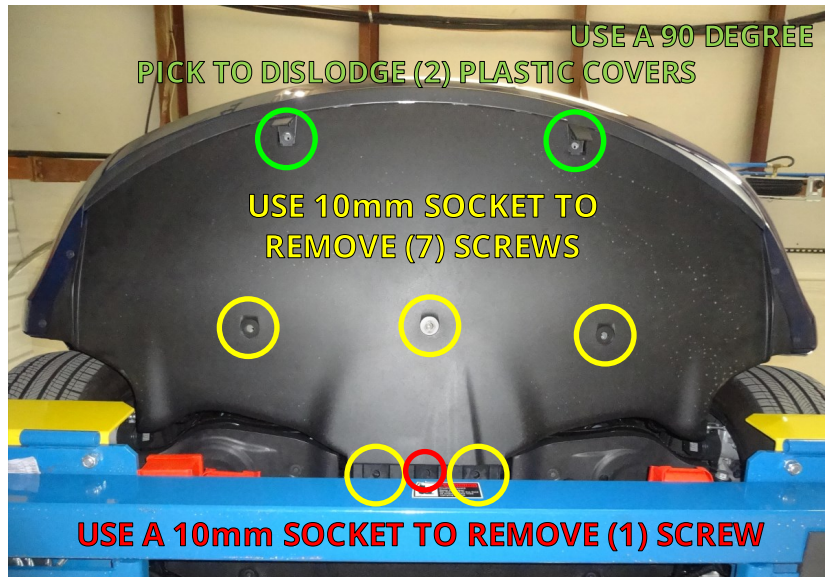

PLASTIC PRY TOOLS



90 DEGREE PICK

9. This step requires a partner. On either side of the vehicle apply outward pressure on the forward most part of the fascia. Work towards the rear of the vehicle pushing down and releasing plastic clips until the fascia is free.
10. While one person holds up the loose fascia, Use a 90 degree clip to unclip and unplug sensor plug on passenger side. **Plug is not present on some 2022+ models**



**NOTICE: Carefully remove the fascia and place on a blanket or pad.**

## INSTALL STEALTH HITCH FRAME



10mm SOCKET

11. Remove (5) screws from plastic trim piece. Let the trim piece hang down to gain access to reinforcement beam base plates, see Step 13. **Save** screws for later reinstallation.

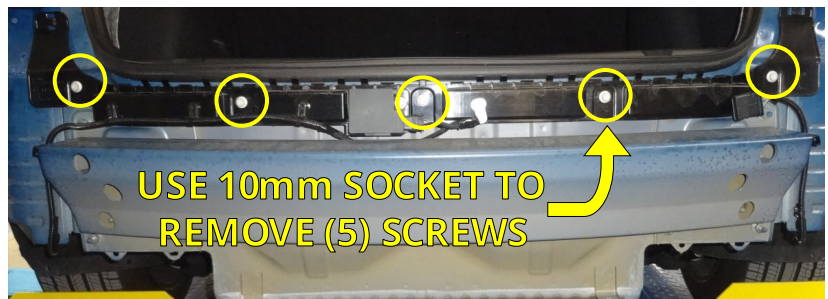

- TIP: Mark the outside of each screw before removal. Use the marks when replacing the trim piece to place it exactly where it was before removal.



## GAIN ACCESS TO MOUNTING AREA



15mm  
DEEP WELL  
SOCKET

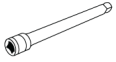

SOCKET  
EXTENSION

12. Remove (6) nuts securing the factory reinforcement beam. Remove reinforcement beam and set aside for later reinstallation.

- NOTE: Some vehicle models may only have (5) Nuts.



15mm  
DEEP WELL  
SOCKET

13. Remove the nuts securing the factory reinforcement beam base plates. Depending on your vehicle model there may be six or eight nuts. **Save** the nuts for the hitch installation. Remove reinforcement beam base plates and discard.

**NOTE:** Only (6) studs may be present on some car models. Continue installation without the use of these (2) stud positions.

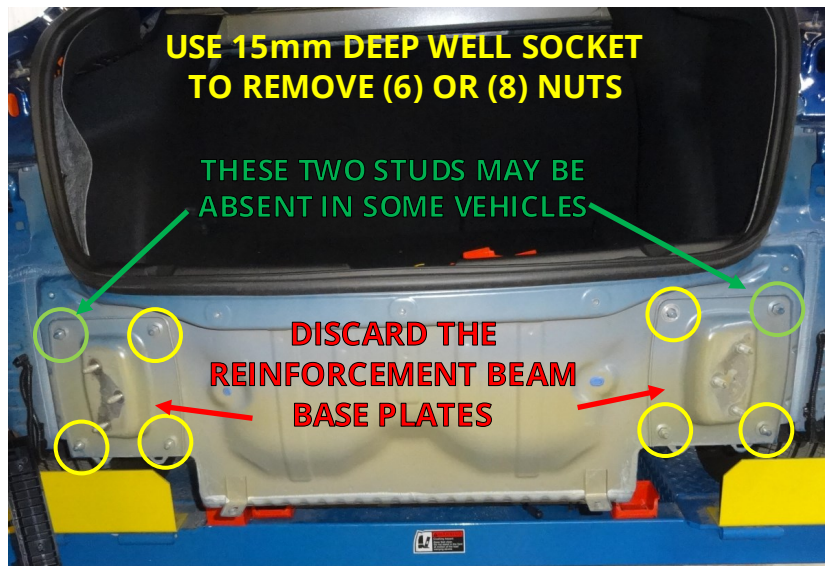

15mm  
DEEP WELL  
SOCKET



TORQUE  
WRENCH

14. Scrape any factory sealant from the body around the studs. Place the supplied nylon washers on the factory studs. Install Stealth hitch frame onto the vehicle studs. Secure the outer vehicle studs with saved nuts. Position the Stealth hitch frame in the center of the vehicle. Torque nuts to 45 ft.-lbs.

**PLACE NYLON WASHERS ON  
FACTORY STUDS**



**USE 15mm SOCKET TO TIGHTEN OUTER NUTS**



## GAIN ACCESS TO MOUNTING AREA CONTINUED

15. Attach the two Stealth hitch frame brackets to the Tesla reinforcement beam using (6) M10 1.5 x 35mm bolts, (6) M10 Flat washers, (6) nylon washers, and (6) M10 serrated flange nuts. The Tesla reinforcement beam needs to be aligned so the narrow portion of the beam is towards the ground. The Stealth hitch frame brackets should be oriented so the notch is up. Leave the nuts loose.

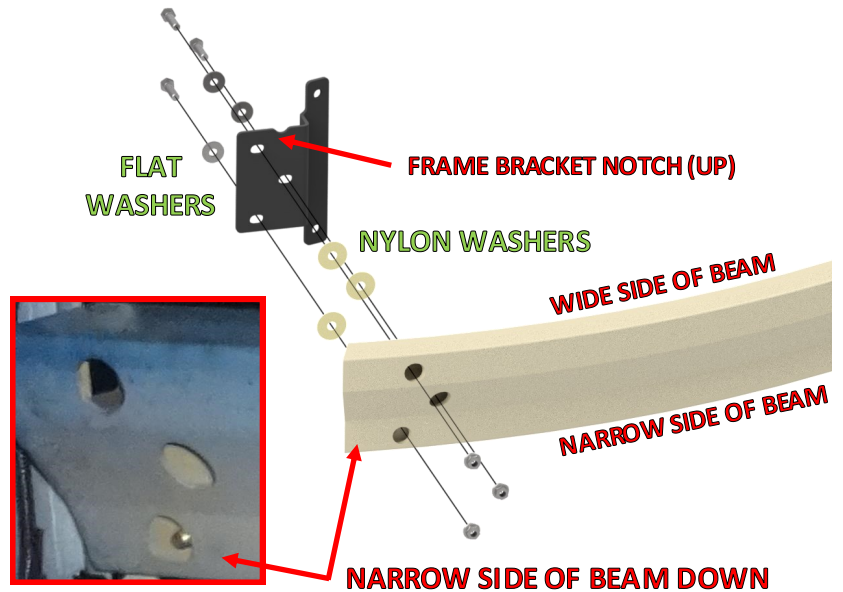

## INSTALL STEALTH HITCH FRAME CONTINUED



15mm  
DEEP WELL  
SOCKET



17mm OPEN END  
WRENCH



TORQUE  
WRENCH

16. Mount the Tesla reinforcement beam assembly onto the inner vehicle studs. Slide Stealth hitch frame brackets as far as possible to the outside of vehicle. Use the (4) saved nuts to secure the brackets. **Position the Tesla reinforcement beam in the center of the vehicle (see tip below).** Tighten & torque all the remaining untightened nuts to 45 ft.-lbs.

USE 17mm WRENCH AND 15mm SOCKET TO  
SECURE (6) M10 BOLTS AND NUTS

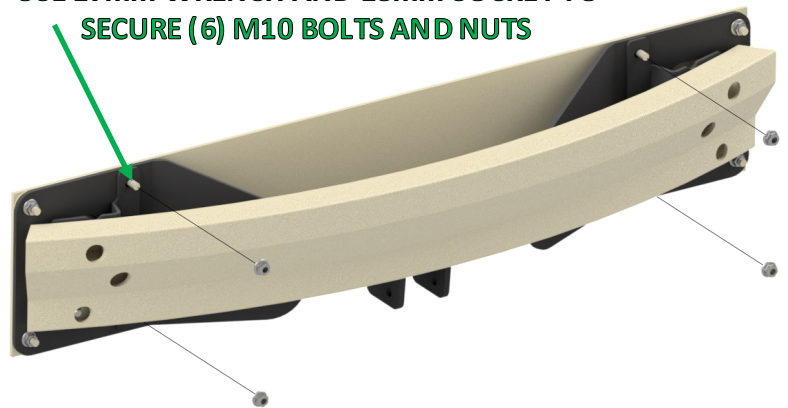

USE 15mm SOCKET TO TIGHTEN REMAINING NUTS

- TIP: Before tightening and torquing the reinforcement beam nuts, measure the distance from the outer edge of the hitch frame to the edge of the reinforcement beam to center the beam. The distance is about 1" on each side.



## MOUNT LATCH BLOCK



15/16"  
SOCKET



15/16" OPEN  
END WRENCH



TORQUE  
WRENCH

17. Installation of the latch block varies depending on which kit you are installing.

- **Rack Receiver Kit:** Install the latch block with (2) 5/8"-11 x 5" bolts and (2) 1/2" nylock nuts. Tighten each bolt to 150 ft.-lbs.

- **Tow Kit:** Install the latch block and (2) chain hooks with (2) 5/8"-11 x 5" bolts and (2) 5/8" nylock nuts. Tighten each bolt to 150 ft.-lbs.

**NOTICE:** Keys are packaged within the latch block, remove keys and store in safe location.

### RACK RECEIVER KIT INSTALL



### TOW KIT INSTALL

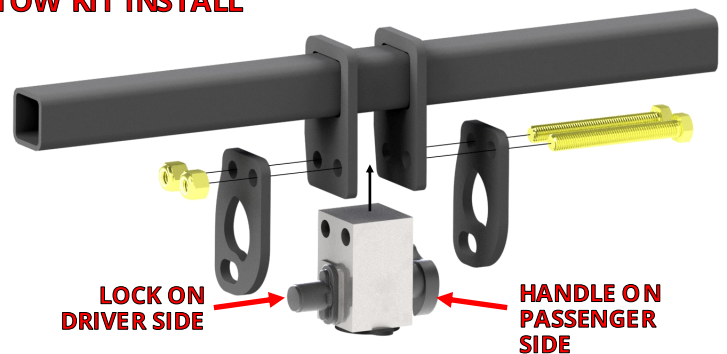

IF INSTALLING A RACK RECEIVER KIT, SKIP TO STEP 42,  
IF INSTALLING A TOW KIT, CONTINUE TO STEP 18.



# INSTALL PASSIVE WIRING KIT

#	DESCRIPTION	QTY
1	4-WAY CONNECTOR HARNESS	1
2	CONTROL MODULE	1
3	4-WAY CONNECTOR COVER	1
4	CABLE TIE - 8"	8
5	CABLE TIE - 14"	2
6	MAGNETIC CABLE HOLDER	1
7	M8 SERRATED FLANGE NUT	1
8	FORK TERMINAL	1
9	ADHESIVE FOAM STRIP	2
10	BUTT CONNECTOR (BLUE)	1
11	BUTT CONNECTOR (RED)	4
12	CLAMP-ON CONNECTORS	4
13	POWER WIRE	1
14	POWER WIRE WITH PLUG	1



18. Locate the wiring kit box. Review the contents of the box against the list above to check for missing components. The passive wiring kit uses a control module to manage the functions of the trailer lighting. The module has an "input" side that receives power from the vehicle's battery and signals from the vehicle's taillights. The "output" side of the module delivers this information to the 4-way plug. The control module is connected to the vehicle's battery and taillight wiring as outlined in the next steps.

**NOTICE: Do not allow electrical system to become disconnected from power or ground. Doing so may interrupt electrical systems.**

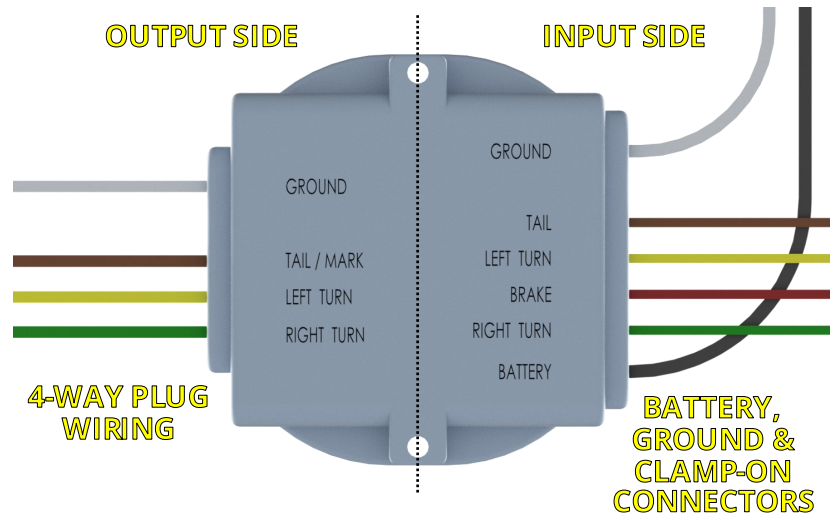

**NOTE: Due to differences between Tesla 3 models, the control module may draw power from a plug near the rear of the vehicle or from the battery in the front of the vehicle, if the plug is not present.**

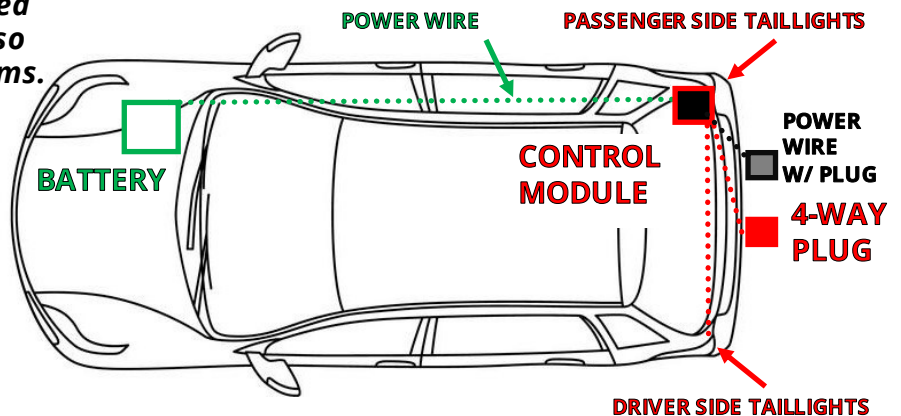

## INSTALL WIRING KIT CONTINUED



DRILL &  
3/8" BIT

19. Remove the grommet from the passenger side rear corner. Drill a hole in the grommet. This grommet will be used to route the output wires and power wire from outside of the vehicle into the inside of the vehicle.



**DRILL A 3/8" HOLE IN GROMMET**



20. Locate the plug connected to the vehicle wiring harness which is shown in the image. It will be located on top of the of the reinforcement beam, near the middle.

**If the plug is not present on your vehicle skip to Step 25**

**If the plug is present continue to Step 21.**

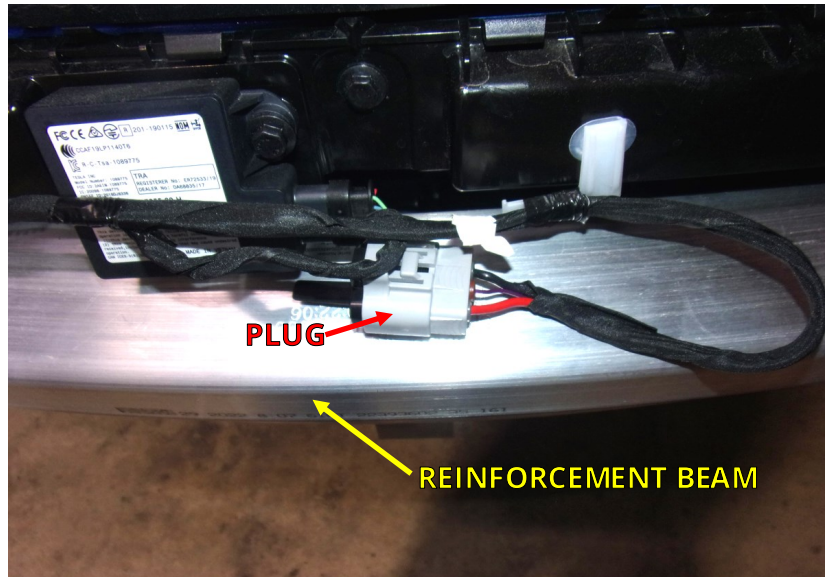

21. Remove the cap present inside the plug by pushing the clip on top downwards. Locate the power wire with plug located in the wiring kit. **Do not connect the plugs together at this time.**

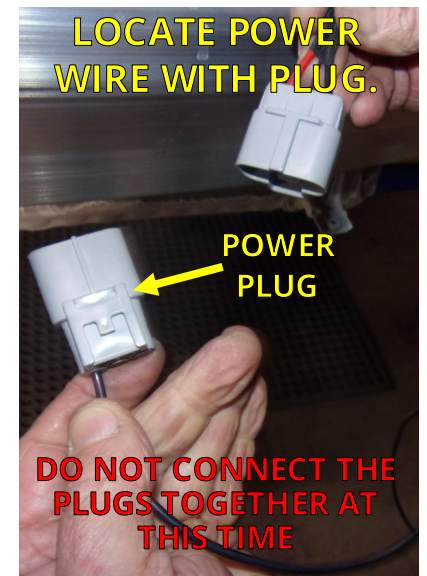



## INSTALL WIRING KIT CONTINUED

22. Feed the black power wire along with the wires of the 4-way output harness into the vehicle through the grommet which had a hole drilled into it earlier.

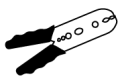
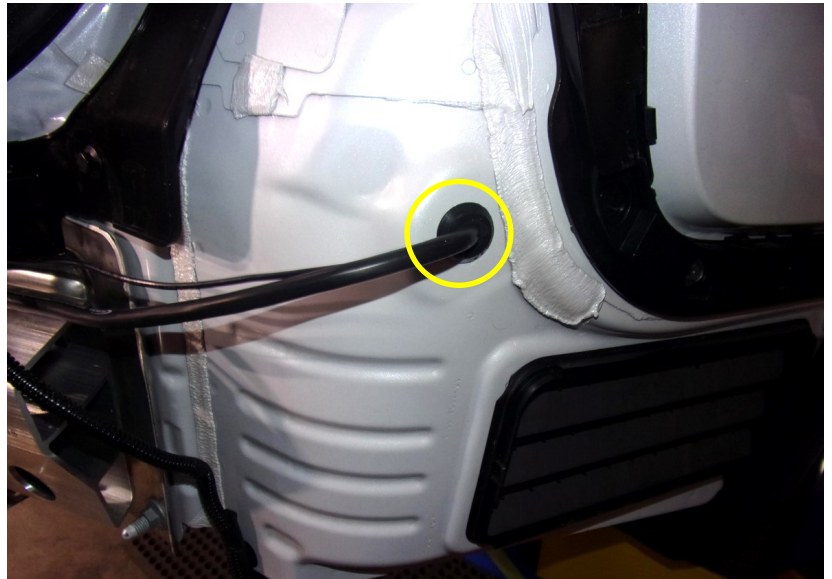

STRIPPER/  
CRIMPING  
TOOL

23. Locate the fuse holder in the wiring kit. Remove the fuse from the fuse holder. Cut off the ring connector. Use a butt splice connector to connect both fuse holder ends to the harness power wire and the power wire from the power plug inside the passenger side panel in the vehicle trunk. Use a crimping tool to secure all wire connections.

**NOTICE (OPTIONAL):** The butt connector is a heat shrink connector. Apply heat to waterproof the connector after crimping.

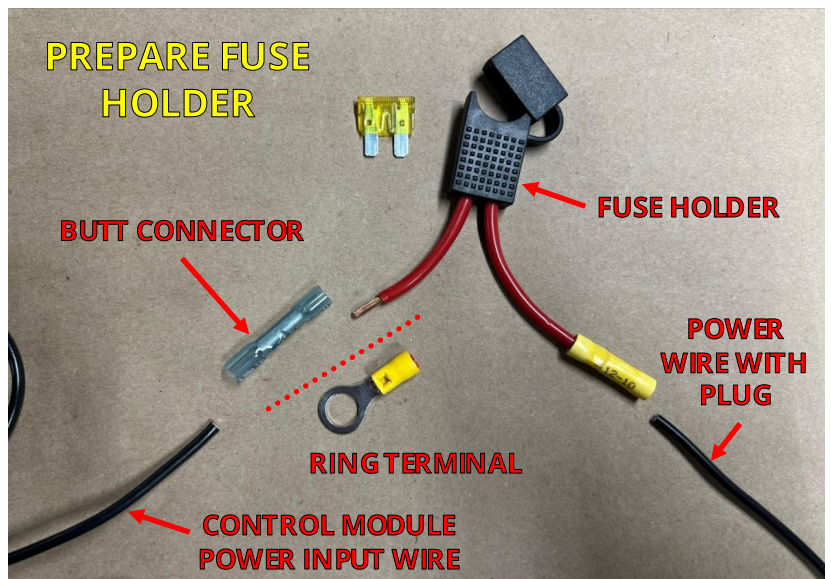

24. Use reference image for complete harness layout when using the power wire plug.

**Skip to Step 33 to continue wiring installation.**

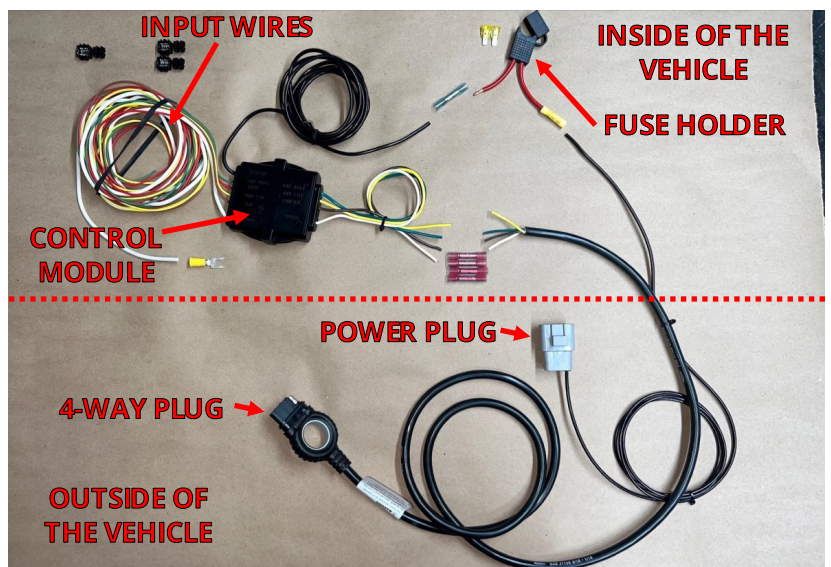



## INSTALL WIRING KIT CONTINUED



90 DEGREE PICK

25. The power wire will be routed through a plastic channel located on the bottom passenger side of the vehicle. In the rear passenger side wheel well, find the (2) plastic push pin rivets located in the front side of the wheel well. Remove the rivets using a 90 degree pick tool to gain access to channel.



90 DEGREE PICK



10mm SOCKET

26. Route the power wire to the front of the vehicle by running the wire over the plastic under body trim. The trim is attached to the vehicle by 10mm screws and/or plastic push pin rivets. Along the trim locate and open the plastic covers and remove the fasteners inside. Some vehicles may also have 10mm screws behind the front tire and in front of the rear tire, remove these screws if present. Pull down the plastic trim and feed the wire into the channel.

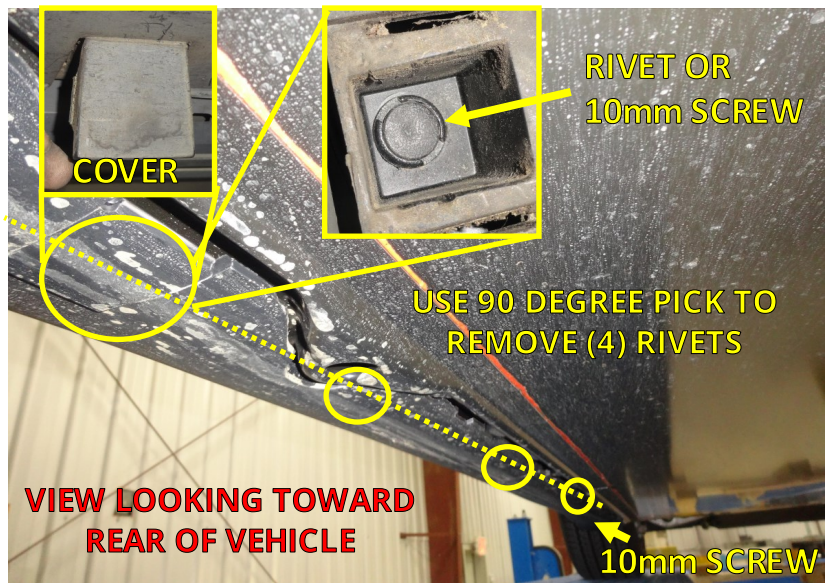

90 DEGREE PICK

27. In the front passenger side wheel well, find the (2) plastic push pin rivets located in the rear side of the wheel well. Remove the rivets using a 90 degree pick tool. The power wire will be routed up into the hood area starting here.





## INSTALL WIRING KIT CONTINUED

28. Remove (2) cover panels to gain access to the battery. Refer to the owner's manual.



90 DEGREE PICK

29. Use a 90 degree pick to dislodge the (4) plastic rivets securing the cabin air filter housing to gain access to the battery.



10mm SOCKET

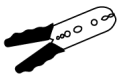

STRIPPER/CRIMPING TOOL

30. Route the power wire from the passenger side wheel well up to the area of the battery. Use a fish tape or similar tool to pull the wire up. Locate the fuse holder supplied in the wiring kit box. Remove the fuse from fuse holder. Crimp fuse lead to power wire and connect to the positive battery terminal (+).





## INSTALL WIRING KIT CONTINUED



8mm  
SOCKET

31. In the rear passenger side wheel well, use a socket to remove (1) nut in the rear wheel well liner. Route the power wire around the wheel well to the rear of the vehicle. Pull any slack out of the power wire.



32. Determine the amount of power wire needed to reach the control module inside the vehicle. Trim the control module power wire to remove excess length. Use the included blue butt connector to crimp the power wire leading from the battery to the control module power wire.

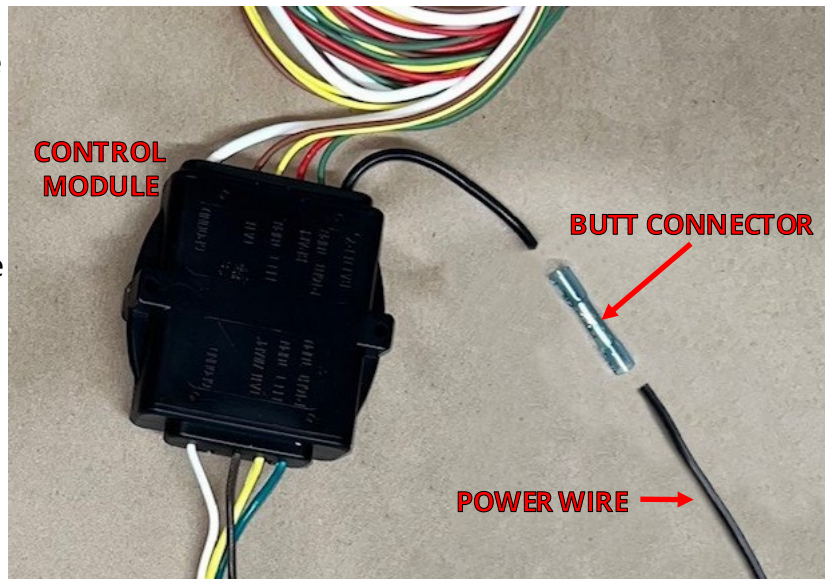

33. On the passenger side of the vehicle, locate the tail of the 4-way connector wire and the output side wires of the control module. Attach each similar color wire to each other using a red butt connector and crimping tool.

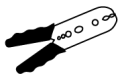

STRIPPER/  
CRIMPING  
TOOL

**NOTICE (OPTIONAL):** The butt connectors are heat shrink connectors. Apply heat to waterproof the connectors after crimping.

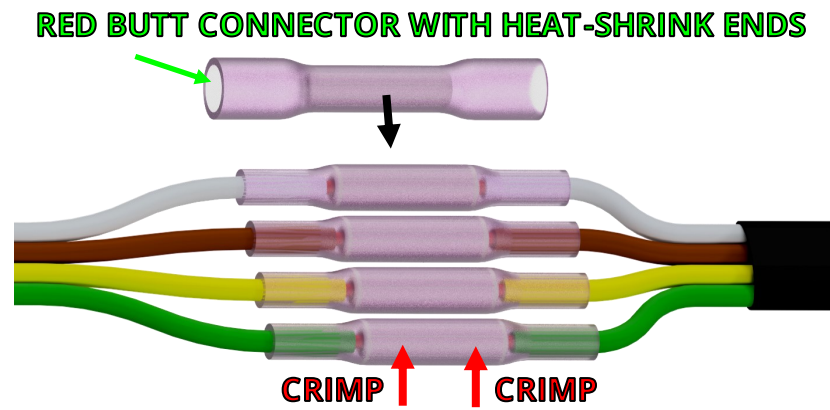

**MATCH THE WIRE COLORS AND CRIMP EACH WIRE INTO THE SIDE OF EACH BUTT CONNECTOR. APPLY HEAT TO WATERPROOF AFTER CRIMPING**

34. Secure harness to Stealth hitch frame with cable ties. Maintain an 18" loop from the cable tie to the 4-way plug. Add the magnetic cable holder and secure to the harness close to the 4-way plug, with a cable tie.

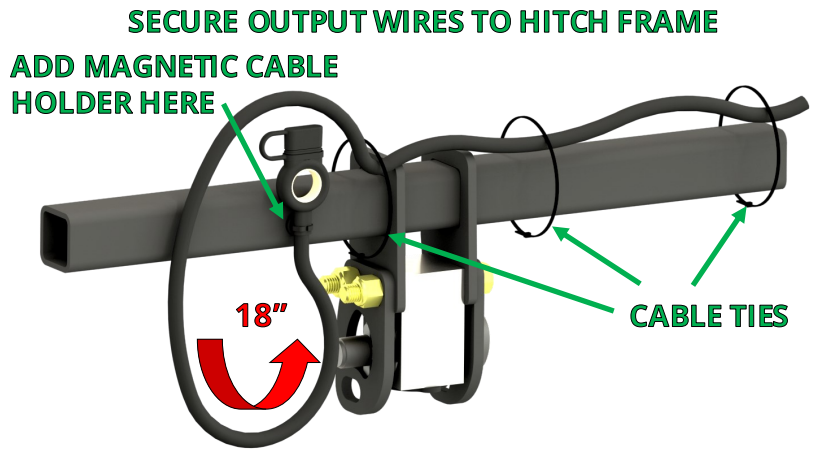

10mm  
SOCKET

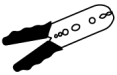

STRIPPER/  
CRIMPING  
TOOL

35. Locate the ground stud in the rear passenger side cargo area. Trim white ground wire so it will reach stud without excess wire. Crimp supplied fork terminal to the ground wire with a crimping tool. Loosen the ground stud and secure the fork to the terminal.

**NOTICE: Loosen ground stud just enough to install fork terminal, so vehicle wiring does not lose ground.**

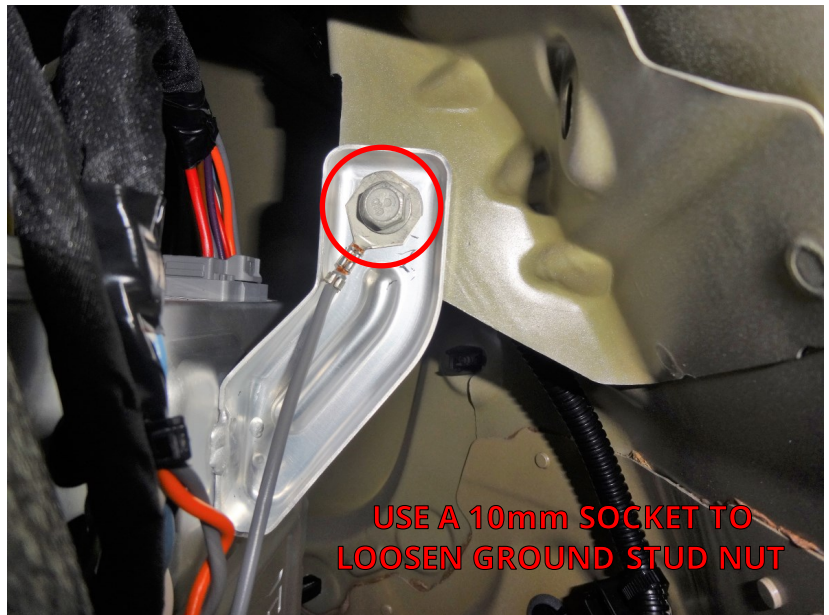

PLIERS



MULTIMETER

36. The wires on the input side of the module need to be attached to the vehicle wiring. In the passenger side of cargo area, remove enough wire loom to gain access to taillight wiring. Use clamp-on connectors to connect the green and brown wires to wires behind taillight. (As shown in reference table on the next page.)

**NOTE: Vehicles may have different wire colors than those shown. Verify circuits (wire colors) with multimeter.**





## INSTALL WIRING KIT CONTINUED



PLIERS















MULTIMETER

37. Using an existing vehicle wire harness as a guide, route the yellow input wire to the driver side of the vehicle. The threshold at the bottom of the trunk opening may need to be removed. Remove enough of the driver side wire loom to gain access to taillight wiring. Use clamp-on connector to clamp the yellow wire to left turn signal wire behind the taillight. (As shown in reference table below.)



### CLAMP-ON CONNECTOR COLOR REFERENCE TABLE

SIGNAL INPUT WIRES			POWER & GROUND WIRES		
FUNCTION	HARNESS	VEHICLE			
<u>LEFT TURN</u>	 YELLOW	 2017-21: PURPLE  2022-2023: RED	<u>12V+ (POWER)</u>	 BLACK	BATTERY (+)
<u>RIGHT TURN</u>	 GREEN	 2017-21: RED  2022-2023: BROWN  OR TAN	<u>GROUND</u>	 WHITE	GROUND STUD
<u>MARKER</u>	 BROWN	 YELLOW	<b><i>NOTICE: Do not connect the red brake wire if vehicle does not utilize a separate brake circuit. When not used, the brake signal is sent down the left and right turn circuits simultaneously.</i></b>		
<u>BRAKE</u>	 RED	 GREY ON <b>SOME</b> 2023 VEHICLES, NOT USED ON MOST VEHICLES. (SEE NOTE)			

**NOTE:** On *some* 2023 vehicles, the red brake wire will need to be connected. To determine if this is the case for your vehicle, use a multimeter to confirm that the brake signal is not transmitted through the left and right turn signal wires but instead is transmitted through the gray wire.



MULTIMETER



SILICONE

38. Plug the power plug into the vehicle harness plug, see Step 20. Reinstall the 20 Amp fuse in the harness fuse holder.

39. Test the 4-way plug using a multimeter or connect the plug to a trailer and verify that the lights and brakes work correctly.

**NOTE:** Taillights will need to be temporarily plugged in during testing.

40. Secure all wires and wiring components. Replace the grommet removed earlier on the rear passenger side of the vehicle. Use the remaining cable ties to secure wiring so that it is not loose and will not interfere with replacement of the fascia. Wiring should not be visible once the vehicle is reassembled. Use the provided adhesive foam strips to secure the control module to an inside body panel. Use silicone to waterproof the grommet in passenger side rear corner.

41. Reattach and secure the underbody plastic channel and the wheel well fender liners. Replace the cover panels under the hood, refer to Steps 18-24.

## CUT FASCIA ACCESS HOLE

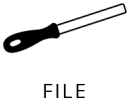

42. Check gravel guard for a factory cover plate. **If included** on your vehicle, use a flathead screwdriver to turn knobs 90 degrees to remove. **If not included**, cut out the gravel guard with a Dremel tool. Use a file to smooth edges of the cut. A template is attached on last instruction page.

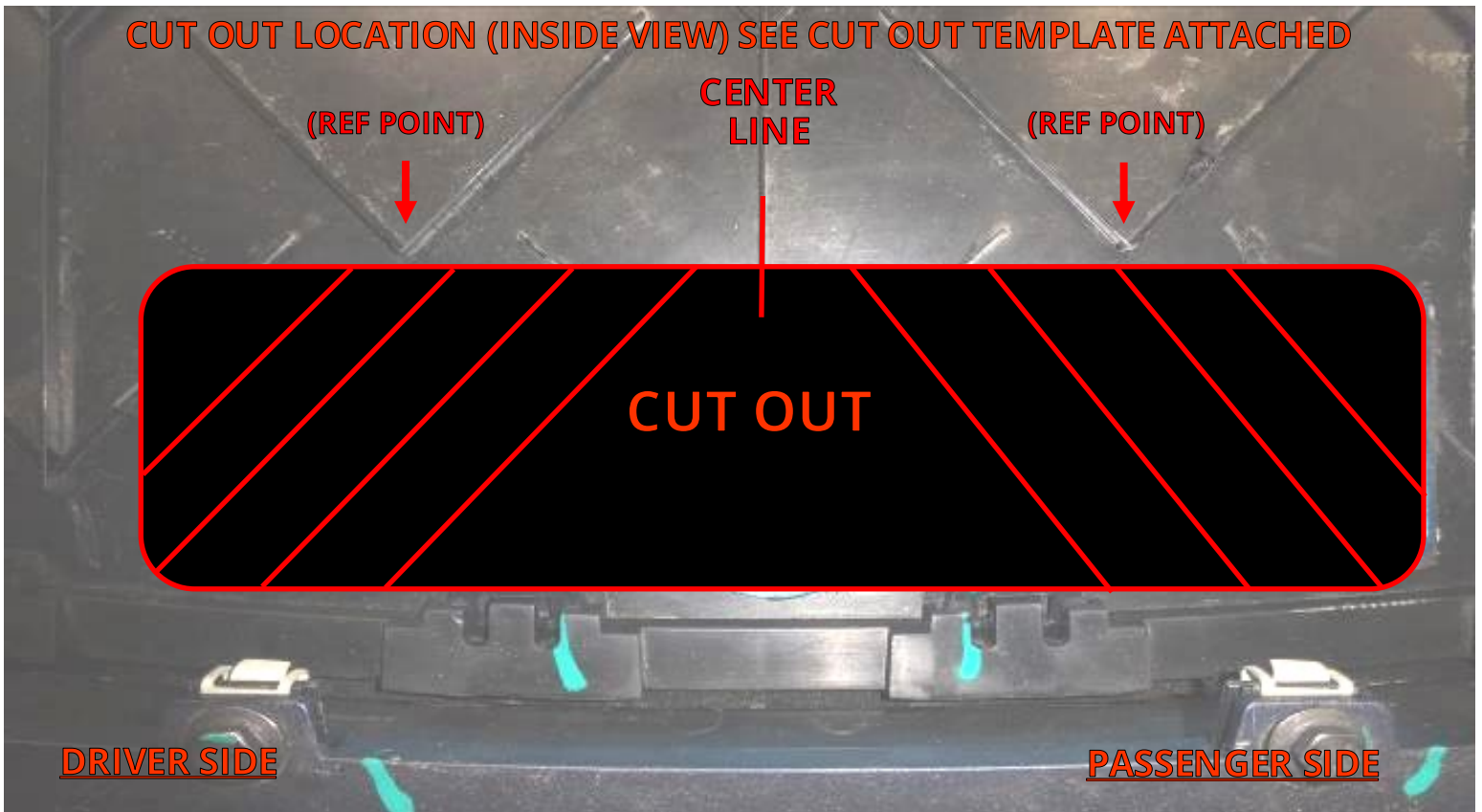
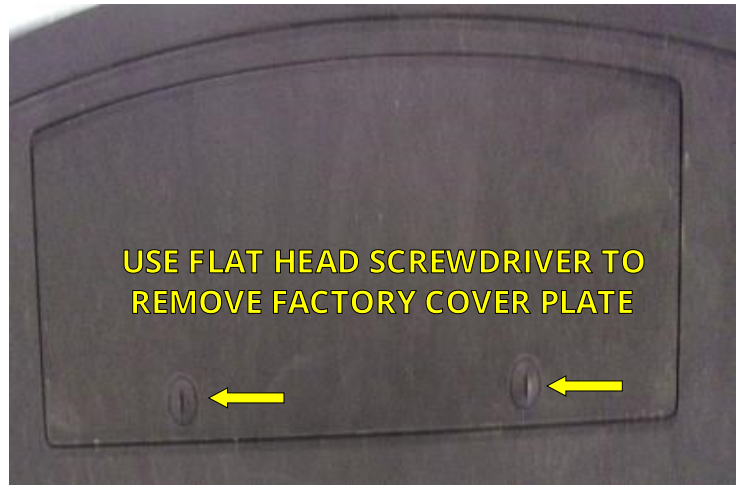



## REINSTALL VEHICLE COMPONENTS

43. Reattach and secure the fascia, taillights, and other vehicle components in reverse order. Refer to Steps 1-10.

**NOTICE:** Replacing the Fascia requires a partner.

**NOTICE:** Remember to plug in the sensor plug in Step 10 before reinstalling the fascia.

**NOTICE:** While replacing the fascia, check that the vehicle wiring harness on top of the factory reinforcement beam is not positioned so it will interfere with the fascia. Adjust wiring if necessary.

**NOTICE:** If present, the (2) tabs on the bottom of the fascia shown in the image (red arrows) must be positioned below the latch block and not against it. If the tabs are against the block the fascia may not attach correctly. The tabs are important to the replacement of the cover panel and should not be removed.

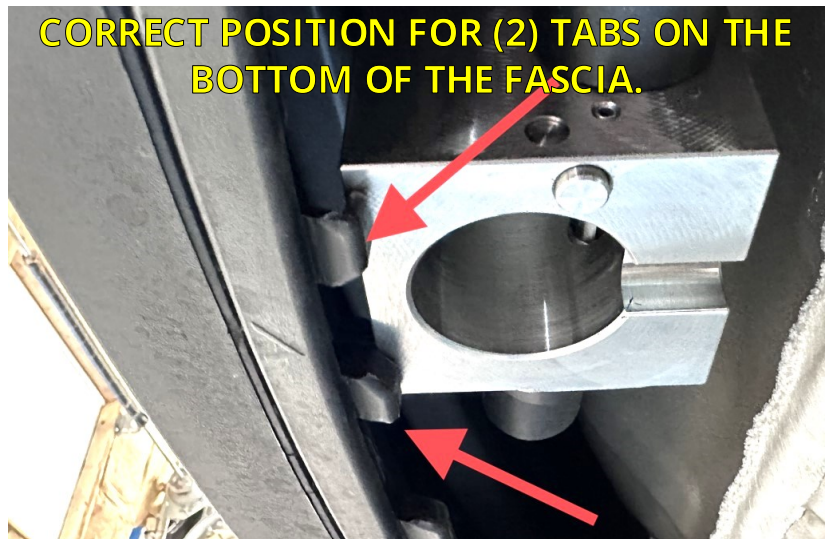

## FINAL VEHICLE EXAMINATION

44. Examine the body panels to ensure that they are in a pre-installation condition. Test the electronic functions of the vehicle. Correct any inconsistencies.
45. Ensure that hitch components work properly.
  - **Verify that the lock works correctly.** Push in the safety lock on the latch block then unlock with key. The lock should slide back out with the key when unlocked.
  - **Verify that each accessory can be installed correctly.** Use the following steps to install and remove each accessory that will be used with the hitch. (*Rack Receiver and Ball Mount if purchased.*)
    1. Prepare latching mechanism. Turn handle clockwise if needed.
    2. Firmly insert “post” of accessory into latch block until handle releases indicating that the accessory is latched.
    3. Push in the safety locking pin until it fully engages. The locking pin prevents the handle from turning when pushed in, and confirms that the block is securely latched onto the accessory. The safety locking pin will not depress if the accessory is not fully latched.
    4. Use key to release safety locking pin.
    5. While holding on to the accessory, rotate handle clockwise to release and remove the accessory.
  - **Verify that no part of the accessories come into contact with the body of the vehicle.**

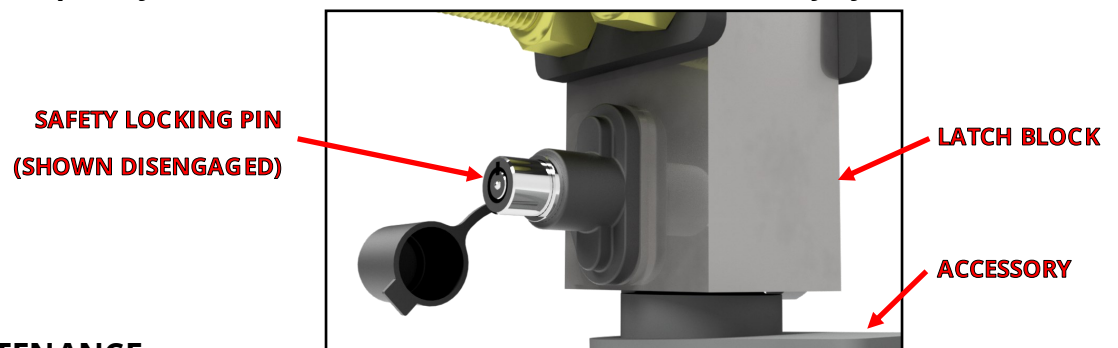

## PRODUCT USE AND MAINTENANCE

**NOTICE: If the hitch is being installed by a professional, the installer is responsible for training the end user in the use and maintenance of the product.**

- **Accessory installation procedure:**
  1. Prepare latching mechanism. Turn handle clockwise if needed.
  2. Firmly insert “post” of accessory into latch block until handle spins counter-clockwise indicating that the accessory is latched.
  3. Always depress the safety locking pin and check that it has fully engaged.
- **Never use any accessory with the safety lock disengaged.** Until the safety locking pin is engaged, the handle is able to turn. A fully engaged safety locking pin is confirmation that the accessory is properly latched into the latch block.
- **Never use the rack receiver for towing.** The rack receiver accessory is only to be used with payload carrying products, such as bike racks or luggage racks.
- **Before each use, give the post of the accessory a light coating of lithium based grease.**
- **Before each use, inspect the hitch to ensure that all bolted connections are secure and that no cracks or damage are present.** Do not tow with the hitch if cracks or damage outside of normal wear is found.
- **Remove the Stealth accessories from the latch block after each use.** Do not leave accessories plugged in for extended periods of time.



***THIS PAGE INTENTIONALLY LEFT BLANK***

***THIS PAGE INTENTIONALLY LEFT BLANK***



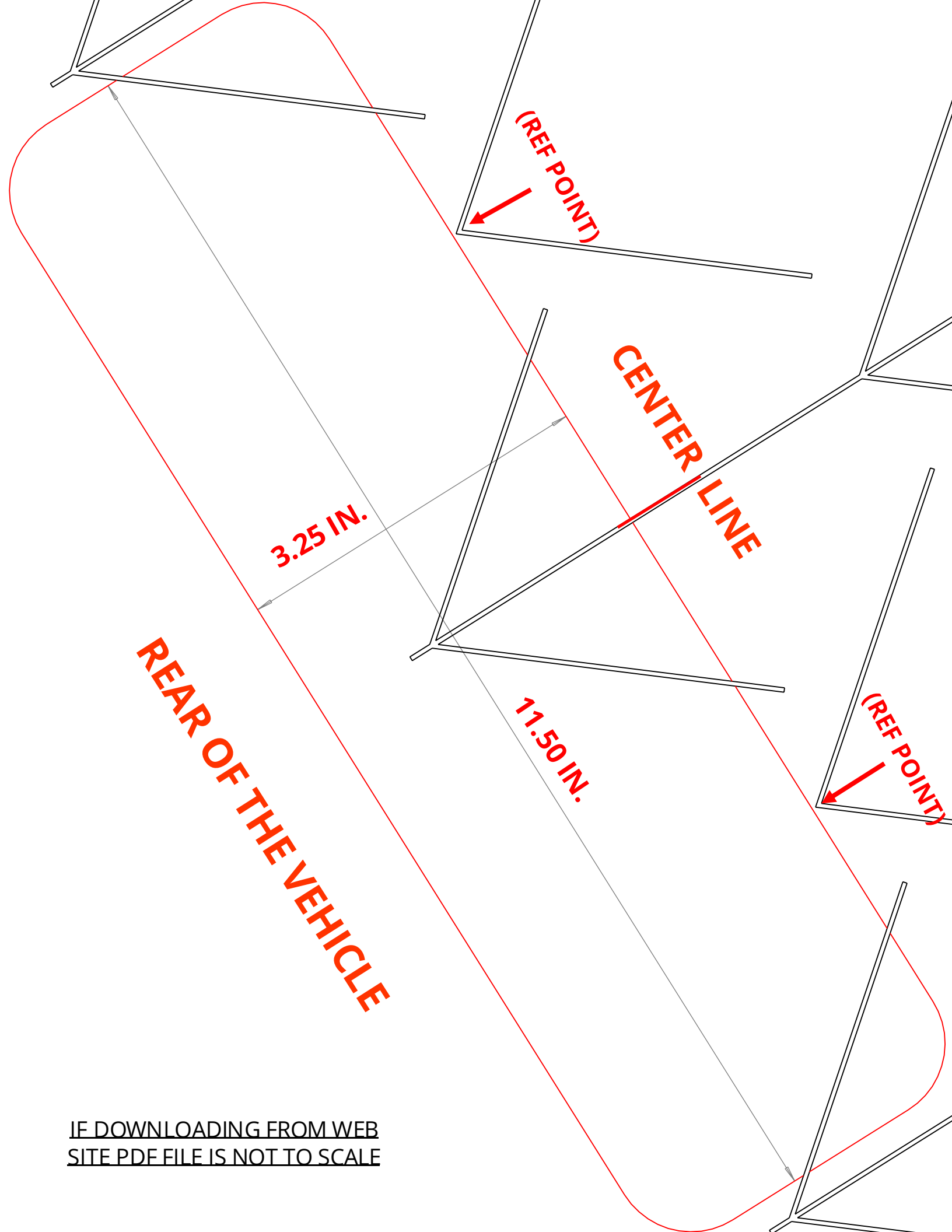

(REF POINT)

CENTER LINE

3.25 IN.

11.50 IN.

(REF POINT)

REAR OF THE VEHICLE

IF DOWNLOADING FROM WEB  
SITE PDF FILE IS NOT TO SCALE